



INDICATIVE PHOTO

## General features : SFM009G001

- Self-supporting casing in zinc-plated metal sheet, which is coated with epoxy powder and easily removable panels for fast access to components during inspection or maintenance operations
- Hermetic compressors with thermal motor protection
- Heat exchangers with copper and aluminium blocks
- Capillary expansion up to the model 54
- Condensation by air (optional by water)
- Automatic defrosting with programmable run, duration and frequency settings
- Electronic board that can be programmed according to different user requirements
- Control panel installed in a remote position
- Electronic control panel
- High pressure switch
- Remote control panel (5m)
- Door micro switch with 2,5m long cable
- Cold room light with 2,5m long cable
- Evaporating water tray
- Door heater cable for LBP items with 2,5m long cable
- Power supply cable (L=2,5m)
- Mounting set and overflow tube
- Package included



Indicative photo

## Product file : Refrigerating systems

Code	SFM009G001
Type	Compact
Mounting	Ceiling
Range	SF
Version	-
Expansion	Capillary
Application	MBP
Gas	R452a
Net weight	84 kg
Ped	0
Defrost	Hot gas

## Compressor

Type	Hermetic
Voltage	220-240/1/50
Displacement	17,4cm <sup>3</sup>

## Pipe fittings

Liquid diam.	-
Suction diam.	-

## Absorptions

Power consumption	1095 W
Current consumption	5,8 A

## Condenser

Fans no.	2
Diameter	254 mm
Air flow	1314 m <sup>3</sup> /h

## Unit cooler

Fans no.	2
Diameter	200 mm
Air flow	1020 m <sup>3</sup> /h
Air throw	3,5 m

## Technical drawing - SFM009G001

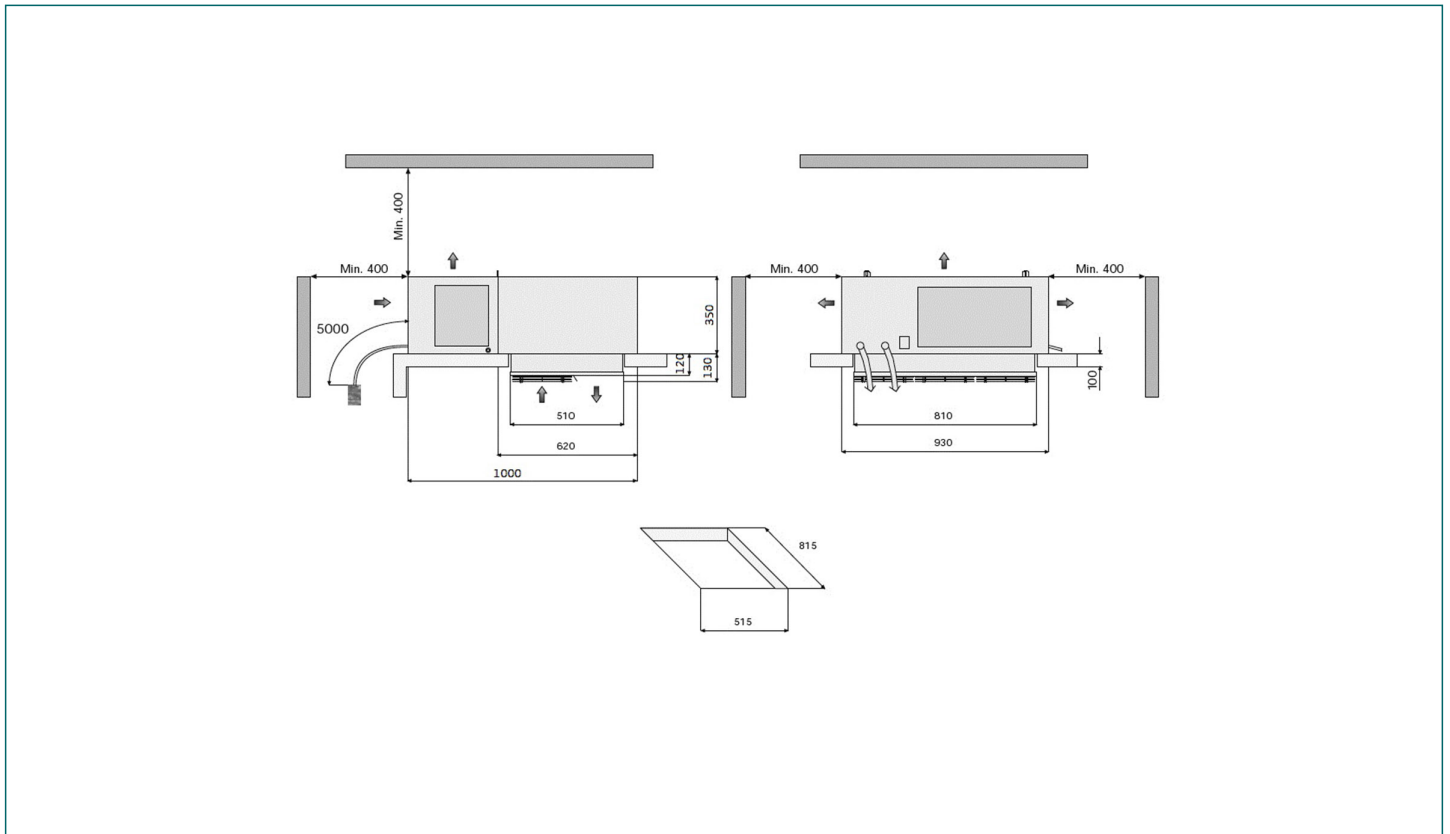

## Refrigerating capacity table (watt) - Gas : R452a

Ta \ Tc	-5°C	0°C	5°C
25°C	1517 (11,7 m³)	1775 (14,9 m³)	2052 (16,5 m³)
32°C	1385 (10,2 m³)	1619 (12,9 m³)	1870 (19,5 m³)
43°C	1154 (7,4 m³)	1349 (9,35 m³)	1557 (14,3 m³)

### Values referred to :

- Suction gas : +20°C
- Subcooling : 0K
- Superheat : 100%
- Compressor absorption :
  - Te -5°C (HBP); Tcond +50°C
  - Te -10°C (MBP); Tcond +50°C
  - Te -30°C (LBP); Tcond +50°C